



Medical

	Type SH5943 24V 150W G6,35-15
	Ordering - No. 55943
Product Description	Special Halogen Lamp
Features	Quartz Bulb, Exactly positioned Filament
Applications	Medical, Microscope, Analysis

Technical Details

Category	HLWS4
Rated Voltage (V)	24
Wattage (W)	max. 165
Luminous Flux (lm)	5000 - 12%
Average Lifetime (h)	300
Base	G6,35-15
Overall Length (mm)	max. 50
Bulb Diameter (mm)	max. 12,5
Light Center Length (mm)	30 ± 0,25
Operating Position	s90
Packaging Configuration	100 pcs.
Environmental Remark	Product don't contain lead or mercury and is conform with Directive 2002/95/EC "Restriction of the use of certain hazardous substances in electrical and electronic equipment".

Drawing (in mm)

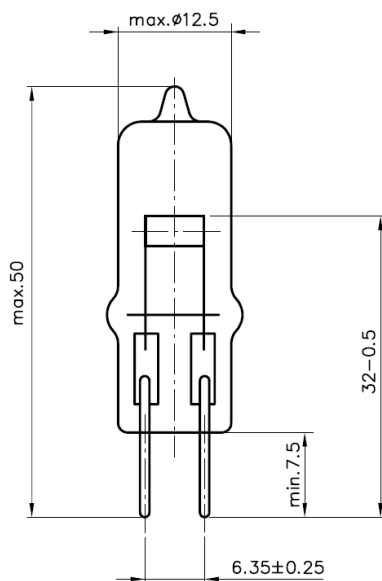

valid from	05.03.2014—V2—PN14/0072
replace for	29.01.2013—V1
file	55943.100.pdf